

AI-701 HIGH PERFORMANCE INTELLIGENT INDICATING/ALARMING INSTRUMENT

Operation Instruction Version 7.0

MAIN FEATURES:

- Programmable and modular inputs, multiple input types of thermocouples and RTDs, voltage/current inputs and two-wire transmitters are field-selectable. Suitable for measuring and displaying temperature, pressure, flow, level, humidity etc with measurement accuracy of 0.2% full scale.
- Dual display windows, convenient to set parameters and alarm points. Various dimensions are selectable.
- Support up to 4 loops of alarms, or 2 loops of high limit alarms plus 2 loops of low limit alarms. Alarms can be outputted to different relays or share one.
- With functions of digital calibrating, digital filtering, and thermocouple cold junction auto compensating, free of maintenance and easy operated.
- Support RS485 communication interface, enable to communicate with computers.
- Retransmission function, cooperating with X3 high precision current output module (0.2%FS), can retransmit temperature with accuracy of 0.3%FS.
- High quality and performance hardware design, using high performance tantalum capacitor or ceramic capacitor. Compared to competing models, it consumes less electricity, experiences less temperature shifting, provides higher stability and reliability and can work in a wider range of temperature. The power and I/O terminals have passed the anti-interference test of 4KV/5KHz burst of pulses.
- Universal 100-240V power supply, with thunderbolt proof and 10 seconds protection from connecting to 380VAC by mistake.

ORDERING CODE

The ordering code of AI-508T is made up of 8 parts, for example:

AI-701 A N X3 L5 N S4 — 24VDC
 ① ② ③ ④ ⑤ ⑥ ⑦ ⑧

This means an instrument with ① model AI-701, ② dimension A (96x96mm), ③ no module in MIO (multiple input/output) slot, ④ X3 linear current output module installed in OUP (main output) slot, ⑤ L5 dual relay output module in ALM (alarm) slot, ⑥ no module in AUX (auxiliary output), ⑦ RS485 communication interface module S4 (with electric isolated power supply) in COMM (communication) slot, and ⑧ 24VDC power supply. The meanings of the 8 parts of ordering code are as below:

① **shows the model of instrument**

AI-701 Indicating/Alarming Instrument with measurement accuracy of 0.2%FS

② **shows the front panel dimension:**

A/A2 Front panel 96×96mm (width×height), cut out 92×92mm, depth behind mounting surface 100mm. A2 has an additional light bar with 25 segments and 4 levels of luminosity which is able to indicate process value

B Front panel 160×80mm (width×height), cut out 152×76mm, depth behind mounting surface 100mm.

C(C3) Front panel 80×160mm (width×height), cut out 76×152mm, depth behind mounting surface 100mm. C3 has an additional light bar with 50 segments and 2 levels of luminosity which is able to indicate process value

D Front panel 72×72mm (width×height), cut out 68×68mm, depth behind mounting surface 95mm

E Front panel 48×96mm (width×height), cut out 45×92mm, depth behind mounting surface 100mm

F Front panel 96×48mm (width×height), cut out 92×45mm, depth behind mounting surface 100mm

③ **shows the module types of multiple input/output (MIO). Selectable modules are as follows:**

V24/V10 Isolated 24V/10V DC voltage output, can supply power for external transmitter or transducer.

I4 4-20mA or 0-20mA analogue input interface, has 24VDC/50mA power supply for two-wire transmitter.

I31 0-10V or 2-10V linear voltage input, has a 24VDC/50mA power supply for external transmitter or transducer.

④ **shows the module types of main output (OUP):** installing X3 current output module can retransmit process value (PV).

⑤ **shows the module type of alarm output (ALM):** can output alarms by installing L1, L2, or L4 relay output module or L5 dual relay output module.

⑥ **shows the module type of auxiliary output (AUX):** can output alarms by installing L1, L2, L4 or L5 relay output module.

⑦ **shows the module type of communication (COMM):** installing S or S4 module can communicate with RS485 interface.

⑧ **shows power supply:** null indicates 100~240VAC power supply, and "24VDC" indicates 20~32VDC/AC power.

Note 1: 4~20mA or 0~20mA standard current signal can be inputted by converting to 1~5V/0~5V voltage signal with a 250 ohm resistor or installing I4

Note 2: D dimension instruments have no MIO slot, and its COMM and ALM share the same slot and can't be installed at the same time. Its ALM only support MIO slot to supply 24VDC power to 2-wire transmitter.

Note 3: The instrument applies the technology of auto zero and digital calibration, and is free of maintenance. If the error exceeds certain range, generally, cleaning and drying the inside of the instrument can fix it. If not, send the instrument back to the factory to examine and repair.

Note 4: Free repair and maintenance will be given in 36 months since the delivery. In order to get full and correct repair, write the phenomena and causes of the malfunction of the instrument.

Note 5: Current module X3 and RS485 communication module S share the same power supply in the instrument, and are not electric isolated to each other. Therefore, if X3 current module is installed in OUP slot and RS485 communication is needed at the same time, then RS485 communication module should be S4 which itself has isolated power supply.















TECHNICAL SPECIFICATION

- **Input type (field selectable) :**
 Thermocouple: K, S, R, T, E, J, B, N, WRe3~WRe25, WRe5~WRe26
 Resistance thermometer: Cu50, Pt100
 Linear voltage: 0~5V, 1~5V, 0~1V, 0~100mV, 0~60mV, 0~20mV, etc.; 0~10V (with I3 module installed in MIO slot)
 Linear current (should connect a external resistor or install I4 module in MIO slot): 0~20mA, 4~20mA
 Linear resistor: 0~80 ohm, 0~400 ohm
- **Measurement range :**
 K(-100~+1300°C), S(0~1700°C), R(0~1600°C), T(-200~+390°C), E(0~800°C), J(0~1000°C), B(600~1800°C), N(0~1300°C),
 WRe3~WRe25(0~2300°C), WRe5~WRe26(0~2300°C), Cu50(-50~+150°C), Pt100(-200~+800°C)
- **Linear input :** -9990~+30000 defined by user
- **Measurement accuracy :** 0.2%FS±0.1°C
- **Temperature display resolution :** 0.1°C (automatically change to 1°C when temperature is greater than 999.9°C), can also choose 1°C
- **Temperature shift :** ≤0.01%FS/°C (typical value is 50ppm/°C)
- **Electromagnetic compatibility (EMC) :** IEC61000-4-4, ±4KV/5KHz; IEC61000-4-5, 4KV
- **Retransmission :** When X3 current module is installed in OUPF slot, process value (PV) can be retransmitted to standard current with maximum load resistor 500 ohm.
- **Alarm function :** High limit, low limit, and second high limit, second low limit.
- **Isolation withstanding voltage :** between power, relay contact or signal terminals ≥2300VDC; between isolated electroweak terminals≥600VDC
- **Power supply :** 100~240VAC, -15%, +10% / 50-60Hz; 120~240VDC; 24VDC/AC, -15%, +10%.
- **Power consumption:** ≤5W
- **Operating Ambient :** temperature -10~+60°C; humidity ≤90%RH
- **Front panel dimension:** 96×96mm, 160×80mm, 80×160mm, 48×96mm, 96×48mm, 72×72mm
- **Panel cutout dimension:** 92×92mm, 152×76mm, 76×152mm, 45×92mm, 92×45mm, 68×68mm
- **Depth behind mounting surface:** ≤100mm

FRONT PANEL AND OPERATION

- ① Upper display window, displays PV, or code of a parameter
- ② Lower display window, displays alarming code or parameter value
- ③ Setup key, for accessing parameter tables, and confirming change.
- ④ Data shift key
- ⑤ Data decrease key
- ⑥ Date increase key
- ⑦ Indicator lamps: OP1, OP2, AL1, AL2, AU1 and AU2 indicate the I/O actions of the corresponding modules.

Basal display status : When power on, the upper display window of the instrument shows the process value (PV), and the lower window shows the setpoint (SV). This status is called basal display status. When the input signal is out of the measurable range (for example, the thermocouple or RTD circuit is break, or input specification sets wrong), the upper display window will alternately display "orAL" and the high limit or the low limit of PV, and the instrument will automatically stop output.

Parameter Setting: In basal display status, press  and hold for about 2 seconds can access Field Parameter Table. If the parameter lock "Loc" isn't locked (Loc=0), we can modify the value of parameters by ,  or . Press  key to decrease the value,  key to increase the value, and  key to move to the digit expected to modify. Keep pressing  or , the speed of decreasing or inscreasing value get quick. Pressing  can go to the next parameter. Press and hold  can return to the preceding parameter. Press  (don't release) and then press  simultaneously can escape from the parameter table. The instrument will escape auomatically from the parameter table if no key is pressed within 30 seconds. Setting Loc=808 and then press  can access System Parameter Table.

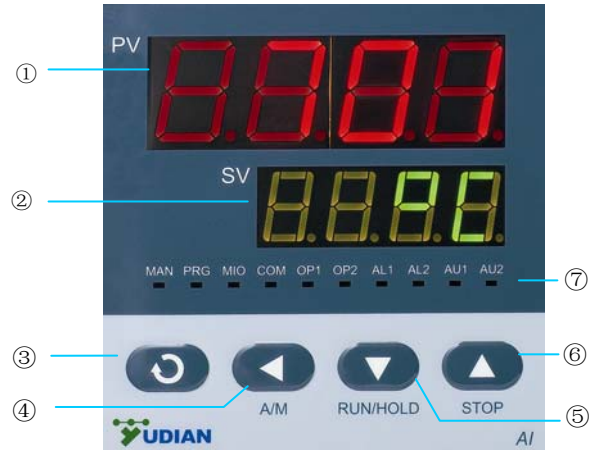

PARAMETER AND SETTING

● Field parameter table (Press and hold for 2 seconds to access)

Code	Name	Description	Setting Range
HIAL	High limit alarm	Alarm on when PV (Process Value) >HIAL; alarm off when PV<HIAL-AHYS Alarm output action can be defined by parameter AOP.	-9990~ 30000
LOAL	Low limit alarm	Alarm on when PV<LoAL; alarm off when PV>LoAL+AHYS	
HdAL	Second high limit alarm	Alarm on when PV>HdAL; alarm off when PV<HdAL-AHYS	
LdAL	Second low limit alarm	Alarm on when PV<LdAL; alarm off when PV>LdAL+AHYS	
Loc	Parameter Lock	0~3: allowed to modify field parameters; 4~255: can only modify "Loc"; set Loc=808, can access system parameter table.	0~9999

● System parameter table (set Loc=808 and then press to access)

AHYS	Alarm Hysteresis	Avoid frequent alarm on-off action because of the fluctuation of PV. For temperature alarm, it is recommended to be 0.5~2℃.	0~200																																																												
AOP	Alarm output assignment	From right side to left side, the first, second, third and fourth digit of AOP individually indicate the alarm output assignment of HIAL, LoAL, HdAL, and LdAL. 0 means no output. 1,2,3 or 4 indicates alarm output to AL1, AL2, AU1 or AU2. For example, $AOP = \begin{array}{cccc} 3 & 3 & 0 & 1 \\ HdAL & LoAL & HIAL & LoAL \end{array}$ It shows that HIAL is output to AL1, LoAL has no output, and HdAL and LoAL are output to AU1.	0~4444																																																												
InP	Input specification	<table border="1"> <thead> <tr> <th>InP</th> <th>Input spec.</th> <th>InP</th> <th>Input spec.</th> </tr> </thead> <tbody> <tr><td>0</td><td>K</td><td>20</td><td>Cu50</td></tr> <tr><td>1</td><td>S</td><td>21</td><td>Pt100</td></tr> <tr><td>2</td><td>R</td><td>26</td><td>0~80ohm resistor input</td></tr> <tr><td>3</td><td>T</td><td>27</td><td>0~400ohm resistor input</td></tr> <tr><td>4</td><td>E</td><td>28</td><td>0~20mV voltage input</td></tr> <tr><td>5</td><td>J</td><td>29</td><td>0~100mV voltage input</td></tr> <tr><td>6</td><td>B</td><td>30</td><td>0~60mV voltage input</td></tr> <tr><td>7</td><td>N</td><td>31</td><td>0~1V voltage input</td></tr> <tr><td>8</td><td>WRe3~WRe25</td><td>32</td><td>0.2~1V voltage input</td></tr> <tr><td>9</td><td>WRe5~WRe26</td><td>33</td><td>1~5V voltage input</td></tr> <tr><td>10</td><td>extended input specification</td><td>34</td><td>0~5V voltage input</td></tr> <tr><td>12</td><td>F2 radiation type pyrometer</td><td>35</td><td>-20~+20mV</td></tr> <tr><td>15</td><td>4~20mA (I4 is installed in MIO)</td><td>36</td><td>-100~+100mV</td></tr> <tr><td>16</td><td>0~20mA (I4 is installed in MIO) 0~10V (I31 is installed in MIO)</td><td>37</td><td>-5~+5V</td></tr> </tbody> </table>	InP	Input spec.	InP	Input spec.	0	K	20	Cu50	1	S	21	Pt100	2	R	26	0~80ohm resistor input	3	T	27	0~400ohm resistor input	4	E	28	0~20mV voltage input	5	J	29	0~100mV voltage input	6	B	30	0~60mV voltage input	7	N	31	0~1V voltage input	8	WRe3~WRe25	32	0.2~1V voltage input	9	WRe5~WRe26	33	1~5V voltage input	10	extended input specification	34	0~5V voltage input	12	F2 radiation type pyrometer	35	-20~+20mV	15	4~20mA (I4 is installed in MIO)	36	-100~+100mV	16	0~20mA (I4 is installed in MIO) 0~10V (I31 is installed in MIO)	37	-5~+5V	0~37
InP	Input spec.	InP	Input spec.																																																												
0	K	20	Cu50																																																												
1	S	21	Pt100																																																												
2	R	26	0~80ohm resistor input																																																												
3	T	27	0~400ohm resistor input																																																												
4	E	28	0~20mV voltage input																																																												
5	J	29	0~100mV voltage input																																																												
6	B	30	0~60mV voltage input																																																												
7	N	31	0~1V voltage input																																																												
8	WRe3~WRe25	32	0.2~1V voltage input																																																												
9	WRe5~WRe26	33	1~5V voltage input																																																												
10	extended input specification	34	0~5V voltage input																																																												
12	F2 radiation type pyrometer	35	-20~+20mV																																																												
15	4~20mA (I4 is installed in MIO)	36	-100~+100mV																																																												
16	0~20mA (I4 is installed in MIO) 0~10V (I31 is installed in MIO)	37	-5~+5V																																																												
dPt	radix point position	Four formats (0, 0.0, 0.00, 0.000) are selectable For thermocouples or RTD inputs, only 0 and 0.0 are selectable, and the internal resolution is 0.1. For linear input, if the value of PV or any parameter is probably greater than 9999, format 0.000 is recommended.	0, 0.0, 0.00, 0.000																																																												
SCL	Signal scale low limit	Define scale low limit of input signal. It is also the scale of the low limit of retransmission output. For example, to transform 1~5V input signal into process value of 0~200.0, we shall set dPt=1, SCL=0, SCH=200.0	-9999~ +30000																																																												
SCH	Signal scale high limit	Define scale high limit of input signal. It is also the scale of the high limit of retransmission output. For example, to transform 0~5V input signal into process value of 1000~2000, we shall set dPt=0, SCL=1000, SCH=2000.																																																													
Scb	Input shift adjustment	Scb is used to compensate the error produced by sensor or input signal. PV_after_compensation= PV_before_compensation + Scb. For example, for the same input signal, if the measured temperature PV is 500.0℃ when Scb=0.0, then PV should be 510.0℃ when Scb=10.0	-1999~ +4000																																																												
FILt	Input filter	The value of FILt will determine the ability of filtering noise. When a large value is set, the measurement input is stabilized but the response speed is slow. Generally, it can be set to 1 to 3. If great interference exists, then you can increase parameter "FILt" gradually to make momentary fluctuation of measured value less than 2 to 5. When the instrument is being metrological verified, "FILt" s can be set to 0 or 1 to shorten the response time.	0~40																																																												
OPt	Output type	1-20: 0~20mA linear current retransmission output; 4-20: 4~20mA linear current retransmission output.																																																													
Addr	communication address	In the same communication line, different instrument on the same should be set to different address.	0~80																																																												
bAud	baud rate	can be set to 4800, 9600 or 19200.	0~ 19200																																																												

TERMINAL LAYOUT AND WIRING

Wiring graph for instruments with dimension A, E or F

Note: The compensation wires for different kinds of thermocouple are different, and should be directly connect to the terminals. Connecting the common wire between the compensation wire and the terminals will cause measurement error.

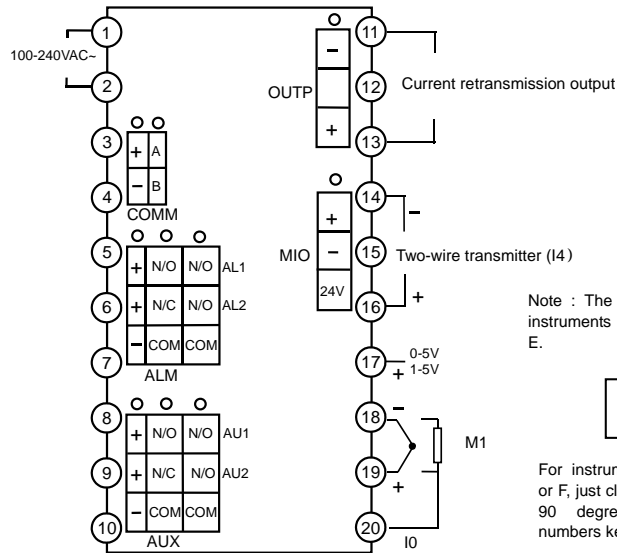

Note : The graph suits for upright instruments with dimension A, C or E.

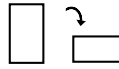

For instruments with dimension B or F, just clockwise rotate the graph 90 degree and the terminal numbers keep the same.

Note: Linear voltage signal with its range below 1V can be inputted from terminals 19 and 18. 0~5V or 1~5V signal can be inputted from terminals 17+ and 18-. Current signal can be converted to voltage signal with an external resistor and then inputted from terminals 17+ and 18-. If I4 module is installed in MIO slot, current signal can also be inputted from terminals 14+ and 15-, and 2-wire transmitter can be inputted from terminals 16+ and 14-. 0~10V voltage signal can be inputted from terminals 14+ and 15- with I31 module installed in MIO slot.

Wiring graph for D dimension (72mmX72mm) instruments

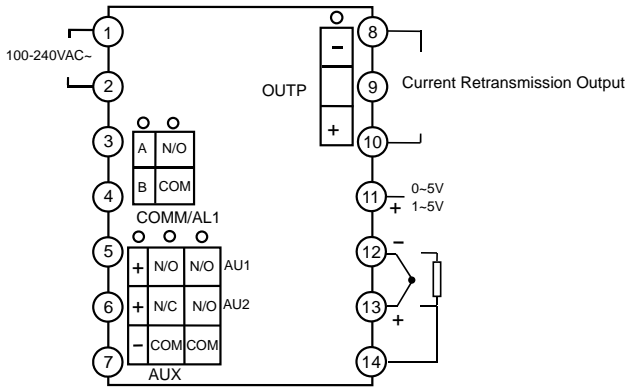

Note: Linear voltage signal of range below 1V should be inputted from terminals 13 and 12, and signal of 0~5V and 1~5V should be inputted from terminals 11 and 12. 4~20mA linear current signal can be converted to 1~5V voltage signal with a 250 ohm resistor and inputted from terminals 11 and 12.